



FCC TCB & IC CB

**Ultratech's
Accreditations:**



0685



91038



1309



46390-2049



NvLap Lab Code 200093-0



SL2-IN-E-1119R



Korea KCC-RRL
CA2049

3000 Bristol Circle,
Oakville, Ontario,
Canada L6H 6G4

Tel.: (905) 829-1570
Fax.: (905) 829-8050

Website: www.ultratech-labs.com
Email: vic@ultratech-labs.com

April 16, 2010

Elprotronic Inc.

16 Crossroads Drive
Richmond Hill, Ontario
Canada, L4E 5C9

Attn.: Dr. Gregory Czajkowski

**Subject: Declaration of Conformity (DoC) Authorization under FCC
PART 15, SUBPART B, Class B - Computing Devices.**

**Product: Flash Programming Adapter
Model No.: USB-FPA**

Dear Dr. Czajkowski,

The product sample, as provided by you, has been tested and found to comply with **FCC PART 15, SUBPART B, Class B - Computing Devices.**

Enclosed you will find copies of the engineering report. If you have any queries, please do not hesitate to contact us.

Yours truly,

Tri Minh Luu, P. Eng.,
V.P., Engineering

Encl

FCC DECLARATION OF CONFORMITY (DoC)

Applicant: Elprotronic Inc.
Address: 16 Crossroads Drive
Richmond Hill, Ontario
Canada, L4E 5C9
Contact Person: Dr. Gregory Czajkowski
Phone #: 905-780-5789
Fax #: 905-780-2414
Email Address: Gregory@elprotronic.com

Equipment Type: Computing Devices for Home and Office Use
Product Name: Flash Programming Adapter
Model No.: USB-FPA

**Standard(s) to which
Conformity is Declared:** FCC Part 15, Subpart B - Class B Computing Devices for Home & Office
Use

Date of Authorization: April 16, 2010

- *For detailed information please refer to the engineering test report, UltraTech File No.: ELP-006-FCC15B, dated April 16, 2010.*
- *I, the undersigned, hereby declare that the equipment under test as listed above complies with the applicable standards as specified by Federal Communications Commission (FCC).*

Applicant:

Signature:

Full Name: Dr. Gregory Czajkowski
Title:
Place: 16 Crossroads Drive
Richmond Hill, Ontario, Canada, L4E 5C9

Legal Representative in US:

Signature:

Full Name:
Title:
Place:

VERIFICATION CERTIFICATE

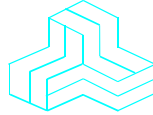

NOT TRANSFERABLE

This Verification Certificate is hereby issued to the named GRANTEE and is VALID ONLY for the equipment identified hereon for use under the rules and regulations listed below:

GRANTEE:

Address:	Elprotronic Inc. 16 Crossroads Drive Richmond Hill, Ontario Canada, L4E 5C9
Contact Person:	Dr. Gregory Czajkowski Phone #: 905-780-5789 Fax #: 905-780-2414 Email Address: Gregory@elprotronic.com

Equipment Type:
Product Name:
Model No.:

Computing Devices for Home and Office Use
Flash Programming Adapter
USB-FPA

The above product was tested by UltraTech Engineering Labs Inc. and found to comply with:

FCC Part 15, Subpart B - Class B Computing Devices for Home & Office Use
--

- **Note(s):** See attached report, UltraTech's File No.:ELP-006-FCC15B, dated April 16, 2010 for details and conditions of Verification Compliance.



Approved by: Tri M. Luu, P.Eng.
V.P. – Engineering

UltraTech

3000 Bristol Circle, Oakville, Ontario, Canada, L6H 6G4
Tel.: (905) 829-1570 Fax.: (905) 829-8050

Website: www.ultratech-labs.com Email: vic@ultratech-labs.com, Email: tri@ultratech-labs.com



91038



1309



46390-2049



NvLap Lab Code
200093-0



SL2-IN-E-1119R



Korea KCC-RRL
CA2049

ENGINEERING TEST REPORT

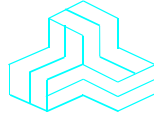

Flash Programming Adapter Model No.: USB-FPA

Applicant: **Elprotronic Inc.**
16 Crossroads Drive
Richmond Hill, Ontario
Canada, L4E 5C9

Tested in Accordance With

**Federal Communications Commission (FCC)
CFR 47, Part 15, Subpart B
Class B Computing Devices**

UltraTech's File No.: ELP-006-FCC15B

This Test report is Issued under the Authority of
Tri M. Luu, Professional Engineer,
Vice President of Engineering
UltraTech Group of Labs

Date: April 16, 2010



Report Prepared by: Phuong Ho

Tested by: Ms. Phuong Ngo & Ms. Nimisha Desai, EMI/EMC Technicians

Issued Date: April 16, 2010

Test Dates: April 13 & 14, 2010

- *The results in this Test Report apply only to the sample(s) tested, and the sample tested is randomly selected.*
- *This report must not be used by the client to claim product endorsement by NVLAP or any agency of the US Government.*

UltraTech

3000 Bristol Circle, Oakville, Ontario, Canada, L6H 6G4
Tel.: (905) 829-1570 Fax.: (905) 829-8050

Website: www.ultratech-labs.com Email: vic@ultratech-labs.com, Email: tri@ultratech-labs.com



91038



1309



46390-2049



NvLap Lab Code
200093-0



SL2-IN-E-1119R



Korea KCC-RRL
CA2049

TABLE OF CONTENTS

EXHIBIT 1. INTRODUCTION	4
1.1. SCOPE	4
1.2. RELATED SUBMITTAL(S)/GRANT(S)	4
1.3. NORMATIVE REFERENCES	4
EXHIBIT 2. PERFORMANCE ASSESSMENT	5
2.1. CLIENT INFORMATION	5
2.2. EQUIPMENT UNDER TEST (EUT) INFORMATION	5
2.3. LIST OF COMPONENTS/PARTS OF THE EUT	6
2.4. LIST OF EUT'S PORTS	6
2.5. ANCILLARY EQUIPMENT	6
EXHIBIT 3. EUT OPERATING CONDITIONS AND CONFIGURATIONS DURING TESTS	8
3.1. CLIMATE TEST CONDITIONS	8
3.2. OPERATIONAL TEST CONDITIONS & ARRANGEMENT FOR TEST SIGNALS	8
3.3. BLOCK DIAGRAM OF TEST SETUP FOR AC POWERLINE CONDUCTED EMISSION & RADIATED EMISSION MEASUREMENTS	9
3.4. PHOTOGRAPHS OF TEST SETUP FOR AC CONDUCTED EMISSION MEASUREMENTS	10
3.5. PHOTOGRAPHS OF TEST SETUP FOR RADIATED EMISSION MEASUREMENTS	12
EXHIBIT 4. SUMMARY OF TEST RESULTS	14
4.1. LOCATION OF TESTS	14
4.2. APPLICABILITY & SUMMARY OF EMC EMISSION TEST RESULTS	14
4.3. MODIFICATIONS REQUIRED FOR COMPLIANCE	14
4.4. DEVIATION OF THE STANDARD TEST PROCEDURES	14
EXHIBIT 5. MEASUREMENTS, EXAMINATIONS & TEST DATA FOR EMC EMISSIONS	15
5.1. TEST PROCEDURES	15
5.2. MEASUREMENT UNCERTAINTIES	15
5.3. MEASUREMENT EQUIPMENT USED	15
5.4. AC POWERLINE CONDUCTED EMISSIONS @ FCC PART 15, SUBPART B, PARA. 15.107(A)	16
5.4.1. Limits	16
5.4.2. Method of Measurements	16
5.4.3. Test Equipment List	16
5.4.4. Test Data	17
5.5. RADIATED EMISSIONS FROM CLASS B COMPUTING DEVICES (DIGITAL DEVICES) @ FCC 15.109(A)	19
5.5.1. Limits	19
5.5.2. Method of Measurements	19
5.5.3. Test Equipment List	19
5.5.4. Test Data	20
5.5.5. Plots	21
EXHIBIT 6. MEASUREMENT UNCERTAINTY	22
6.1. LINE CONDUCTED EMISSION MEASUREMENT UNCERTAINTY	22
6.2. RADIATED EMISSION MEASUREMENT UNCERTAINTY	23
EXHIBIT 7. LABELLING & FCC AUTHORIZATION REQUIREMENTS	24
7.1. SECTION 15.19 - LABELING REQUIREMENTS	24

7.2.	SECTIONS 15.21 - INFORMATION TO USER.....	25
7.3.	SECTIONS 15.105 - INFORMATION TO USER.....	25
7.4.	SECTION 2.906 - DECLARATION OF CONFORMITY (DoC).....	26
7.5.	SECTION 2.909 - RESPONSIBLE PARTY	26
7.6.	SECTION 2.945 - SAMPLING TEST OF EQUIPMENT COMPLIANCE	26
7.7.	SECTION 2.946 - PENALTY FOR FAILURE TO PROVIDE TEST SAMPLES AND DATA.	26
7.8.	LIMITATION ON VERIFICATION: FCC PART 2, SUBPART J, SECTION 2.952.....	27
7.9.	RESPONSIBILITY OF MANUFACTURER OR IMPORTER: FCC PART 2, SUBPART J, SECTION 2.953.....	27
7.10.	IDENTIFICATION: FCC PART 2, SUBPART J, SECTION 2.954.....	27
7.11.	RETENTION OF RECORDS: FCC PART 2, SUBPART J, SECTION 2.955	27
7.12.	FCC INSPECTION & SUBMISSION OF EQUIPMENT FOR TESTING: FCC PART 2, SUBPART J, SEC. 2.956	28
7.13.	SAMPLING TESTS OF EQUIPMENT COMPLIANCE: FCC PART 2, SUBPART J, SECTION 2.957	28
EXHIBIT 8.	PHOTOGRAPHS OF EQUIPMENT UNDER TEST	29

EXHIBIT 1. INTRODUCTION

1.1. SCOPE

Reference:	FCC Part 15, Subpart B, Sections 15.107 & 15.109
Title	Telecommunication - Code of Federal Regulations, CFR 47, Part 15
Purpose of Test:	To gain FCC Declaration of Conformity (DoC) Authorization for a Class B Unintentional Radiator.
Test Procedures	Both conducted and radiated emissions measurements were conducted in accordance with American National Standards Institute ANSI C63.4 - American National Standard for Methods of Measurement of Radio-Noise Emissions from Low-Voltage Electrical and Electronic Equipment in the Range of 9 kHz to 40 GHz.
Environmental Classification:	Residential, Light-industry, Commercial & Industry

1.2. RELATED SUBMITTAL(S)/GRANT(S)

None

1.3. NORMATIVE REFERENCES

Publication	Year	Title
CISPR 22 EN 55022	2008-09, Edition 6.0 2006	Information Technology Equipment - Radio Disturbance Characteristics - Limits and Methods of Measurement
ANSI C63.4	2003	American National Standard for Methods of Measurement of Radio-Noise Emissions from Low-Voltage Electrical and Electronic Equipment in the Range of 9 KHz to 40 GHz
CISPR 16-1-1 +A1 +A2	2006 2006 2007	Specification for radio disturbance and immunity measuring apparatus and methods. Part 1-1: Measuring Apparatus
CISPR 16-1-2 +A1: 2004 +A2: 2006	2003	Specification for radio disturbance and immunity measuring apparatus and methods. Part 1-2: Conducted disturbances
FCC 47 CFR 15	2008	Code of Federal Regulations – Telecommunication

EXHIBIT 2. PERFORMANCE ASSESSMENT

2.1. CLIENT INFORMATION

APPLICANT:	
Name:	Elprotronic Inc.
Address:	16 Crossroads Drive Richmond Hill, Ontario Canada, L4E 5C9
Contact Person:	Dr. Gregory Czajkowski Phone #: 905-780-5789 Fax #: 905-780-2414 Email Address: Gregory@elprotronic.com

MANUFACTURER:	
Name:	Elprotronic Inc.
Address:	16 Crossroads Drive Richmond Hill, Ontario Canada, L4E 5C9
Contact Person:	Dr. Gregory Czajkowski Phone #: 905-780-5789 Fax #: 905-780-2414 Email Address: Gregory@elprotronic.com

2.2. EQUIPMENT UNDER TEST (EUT) INFORMATION

The following information (with the exception of the Date of Receipt) has been supplied by the applicant.

Brand Name	Elprotronic Inc.
Product Name	Flash Programming Adapter
Model Name or Number	USB-FPA
Serial Number	20100562
Type of Equipment	Computing Devices
Oscillators' Frequencies	24.00 MHz
CPUs' Frequencies	48.00 MHz (CPU), 480.0 MHz (SIE), 1.0 MHz (Aux.CPU)
Power input source:	DCderived from host (from PC via USB)

2.3. LIST OF COMPONENTS/PARTS OF THE EUT

None

2.4. LIST OF EUT'S PORTS

Port Number	EUT's Port Description	Number of Identical Ports	Connector Type	Cable Type (Shielded/Non-shielded)
1	USB	1	USB type B	shielded
2	Ribbon cable	1	14-pins header	Non-shielded

2.5. ANCILLARY EQUIPMENT

The EUT was tested while connected to the following representative configuration of ancillary equipment necessary to exercise the ports during tests:

Ancillary Equipment # 1	
Brand name:	HP PC Pavilion a1106n
Serial Number:	MXK52707SC
Prod. Number:	PY028AA-ABA
Cable Type:	Shielded
Connected to EUT's Port:	USB

Ancillary Equipment # 2	
Brand name:	Acer LCD Monitor
Model Name or Number:	X223W
Part Number:	EX3WP001
Serial Number:	ETLAZ090478130394A3610
Cable Type:	Shielded
Connected to PC's Port:	HD15

Ancillary Equipment # 3	
Brand name:	Dell Keyboard
Model Name or Number:	RT7D5JTW
Serial Number:	37172-990-2445
Cable Type:	Shielded
Connected to PC's Port:	PS2

Ancillary Equipment # 4	
Brand name:	Microsoft Mouse
Part Number:	X800472-145
PID:	55250-576-2785502-0
Cable Type:	Shielded
Connected to PC's Port:	PS2

Continued...

Ancillary Equipment # 5	
Brand name:	Dell Speaker
Model Name or Number:	CN0D3431-48220-4CL-032φ
Cable Type:	Non-shielded
Connected to PC's Port:	¼ " Jack

Ancillary Equipment # 6	
Brand name:	T Sound Headphone
Model Name or Number:	None
Serial Number:	None
Cable Type:	Non-shielded
Connected to PC's Port:	PS2

EXHIBIT 3. EUT OPERATING CONDITIONS AND CONFIGURATIONS DURING TESTS

3.1. CLIMATE TEST CONDITIONS

The climate conditions of the test environment are as follows:

Temperature:	21°C
Humidity:	51%
Pressure:	102 kPa
Power input source:	DC derived from host (from PC via USB)

3.2. OPERATIONAL TEST CONDITIONS & ARRANGEMENT FOR TEST SIGNALS

The USB-FPA Flash Programming Adapter, powered from PC via USB cable is dedicated to program the microcontroller's flash memory or communicate with the microcontroller's for debugging purpose. PC software is making communication with the USB-FPA during the test.

3.3. BLOCK DIAGRAM OF TEST SETUP FOR AC POWERLINE CONDUCTED EMISSION & RADIATED EMISSION MEASUREMENTS

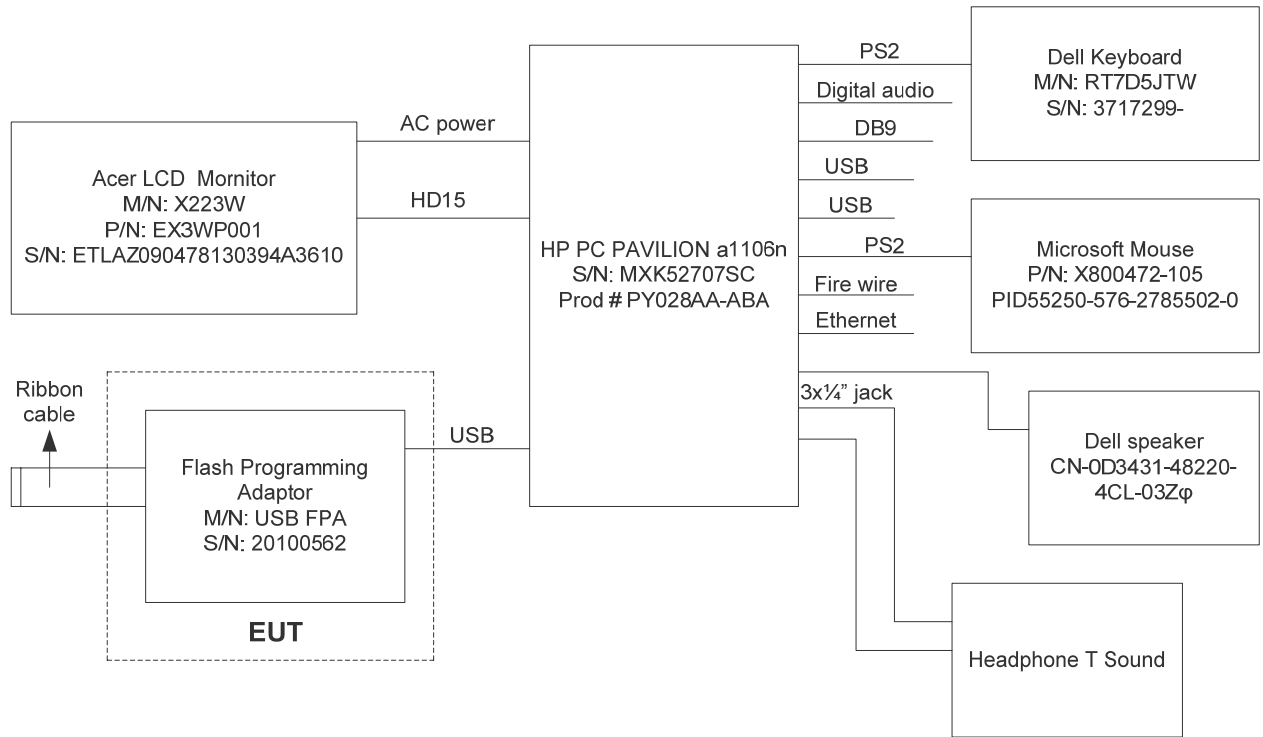

3.4. PHOTOGRAPHS OF TEST SETUP FOR AC CONDUCTED EMISSION MEASUREMENTS





3.5. PHOTOGRAPHS OF TEST SETUP FOR RADIATED EMISSION MEASUREMENTS





EXHIBIT 4. SUMMARY OF TEST RESULTS

4.1. LOCATION OF TESTS

All of the measurements described in this report were performed at Ultratech Group of Labs located in the city of Oakville, Province of Ontario, Canada.

- AC Powerline Conducted Emissions were performed in UltraTech's shielded room, 16'(L) by 12'(W) by 12'(H).
- Radiated Emissions were performed at the Ultratech's 3-10 TDK Semi-Anechoic Chamber situated in the Town of Oakville, province of Ontario. This test site been calibrated in accordance with ANSI C63.4, and found to be in compliance with the requirements of Sec. 2.948 of the FCC Rules. The descriptions and site measurement data of the Oakville 3-10 TDK Semi-Anechoic Chamber has been filed with FCC office (FCC File No.: 91038) and Industry Canada office (Industry Canada File No.: 2049A-3). Expiry Date: 2011-05-01.

4.2. APPLICABILITY & SUMMARY OF EMC EMISSION TEST RESULTS

FCC PART 15, SUBPART B	TEST REQUIREMENTS	MARGIN BELOW (-) / ABOVE (+) THE LIMITS	COMPLIANCE (YES/NO)
15.107(a), Class B	AC Power Line Conducted Emissions Measurements	- 11.1 dB @ 0.153 MHz	Yes
15.109(a), Class B	Radiated Emissions from Computing Devices (Digital Devices)	- 1.6 dB @ 900.00 MHz	Yes

4.3. MODIFICATIONS REQUIRED FOR COMPLIANCE

None

4.4. DEVIATION OF THE STANDARD TEST PROCEDURES

None

EXHIBIT 5. MEASUREMENTS, EXAMINATIONS & TEST DATA FOR EMC EMISSIONS

5.1. TEST PROCEDURES

Please refer to Ultratech Test Procedures, File# ULTR-P001-2004, ANSI C63.4, CISPR 22 / EN 55022, CISPR 16-1-2 and CISPR 16-2-3 for Test Procedures.

5.2. MEASUREMENT UNCERTAINTIES

The measurement uncertainties stated were calculated in accordance with requirements of UKAS Document LAB 34 with a confidence level of 95%. Please refer to Exhibit 6 for Measurement Uncertainties.

5.3. MEASUREMENT EQUIPMENT USED

The measurement equipment used complied with the requirements of the Standards referenced in the Methods & Procedures ANSI C63.4 and CISPR 16-1-1.

5.4. AC POWERLINE CONDUCTED EMISSIONS @ FCC PART 15, SUBPART B, PARA.15.107(A)

5.4.1. Limits

The equipment shall meet the limits of the following table:

Test Frequency Range (MHz)	CLASS B LIMITS		Measuring Bandwidth
	Quasi-Peak (dB μ V)	Average* (dB μ V)	
0.15 to 0.5	66 to 56*	56 to 46*	RBW = 9 kHz VBW \geq 9 kHz for QP VBW = 10 Hz for Average
0.5 to 5	56	46	RBW = 9 kHz VBW \geq 9 kHz for QP VBW = 10 Hz for Average
5 to 30	60	50	RBW = 9 kHz VBW \geq 9 kHz for QP VBW = 10 Hz for Average

* Decreasing linearly with logarithm of frequency

5.4.2. Method of Measurements

Refer to Ultratech Test Procedures ULTR-P001-2004 & ANSI C63.4 for method of measurements.

5.4.3. Test Equipment List

Test Instruments	Manufacturer	Model No.	Serial No.	Frequency Range
EMI Receiver System/Spectrum Analyzer	Hewlett Packard	HP 8546A	3650A00371	9kHz-6.5GHz,
Transient Limiter	Pasternack	PE7010-20	---	DC to 2 GHz 20dB attenuation
L.I.S.N.	EMCO	3825/2	8907-1531	10 kHz – 100 MHz
12'x16'x12' RF Shielded Chamber	RF Shielding

5.4.4. Test Data

Current Graph

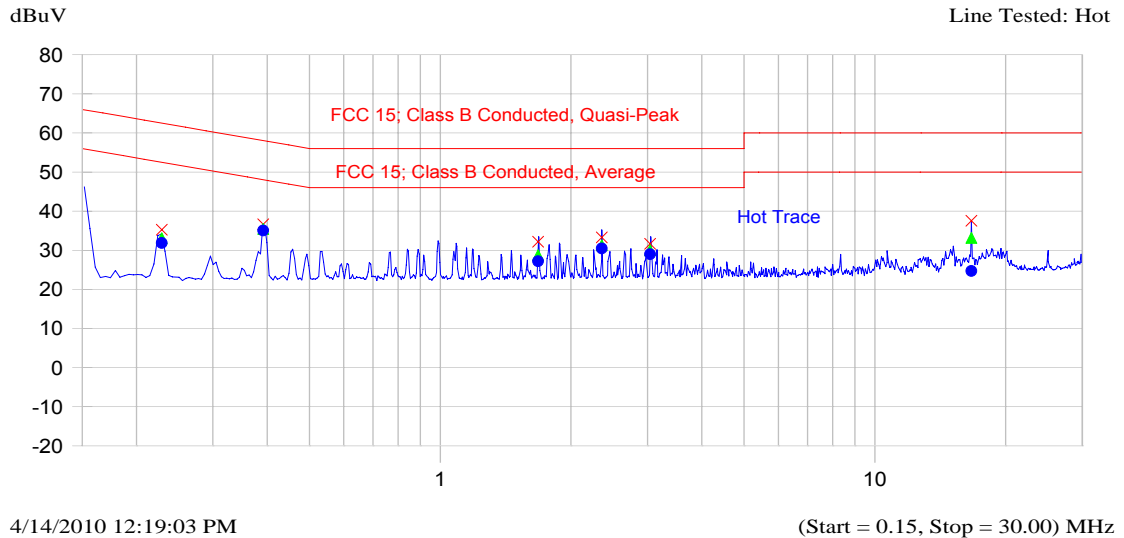

Current List

Frequency MHz	Peak dBuV	QP dBuV	Delta QP-QP Limit dB	Avg dBuV	Delta Avg-Avg Limit dB	Trace Name
0.229	35.3	33.1	-30.6	31.9	-21.8	Hot Trace
0.391	36.7	35.5	-23.6	35.1	-14.0	Hot Trace
1.678	32.2	28.7	-27.3	27.2	-18.8	Hot Trace
2.353	33.3	31.3	-24.7	30.5	-15.5	Hot Trace
3.040	31.7	30.0	-26.0	29.0	-17.0	Hot Trace
16.673	37.5	33.1	-26.9	24.7	-25.3	Hot Trace

Current Graph

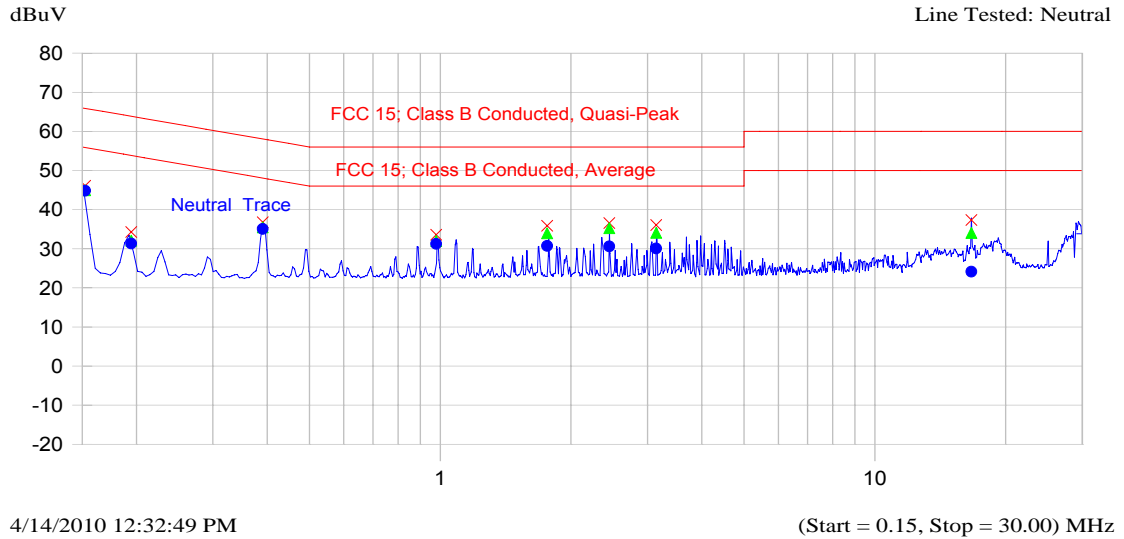

Current List

Frequency MHz	Peak dBuV	QP dBuV	Delta QP-QP Limit dB	Avg dBuV	Delta Avg-Avg Limit dB	Trace Name
0.153	46.1	44.9	-21.0	44.8	-11.1	Neutral Trace
0.195	34.2	32.1	-32.6	31.3	-23.4	Neutral Trace
0.391	36.8	35.5	-23.6	35.1	-14.0	Neutral Trace
0.979	33.5	32.0	-24.0	31.2	-14.8	Neutral Trace
1.763	35.9	33.9	-22.1	30.7	-15.3	Neutral Trace
2.450	36.6	35.3	-20.7	30.6	-15.4	Neutral Trace
3.139	36.0	34.1	-21.9	30.1	-15.9	Neutral Trace
16.686	37.3	34.0	-26.0	24.1	-25.9	Neutral Trace

5.5. RADIATED EMISSIONS FROM CLASS B COMPUTING DEVICES (DIGITAL DEVICES) @ FCC 15.109(A)

5.5.1. Limits

The equipment shall meet the limits of the following table:

Test Frequency Range (MHz)	Class B Limits @ 10 m (dB μ V/m)	EMI Detector Used	Measuring Bandwidth (kHz)
30 – 88	29.5	Quasi-Peak	RBW = 120 kHz, VBW \geq 120 kHz
88 – 216	33.0	Quasi-Peak	RBW = 120 kHz, VBW \geq 120 kHz
216 – 960	35.5	Quasi-Peak	RBW = 120 kHz, VBW \geq 120 kHz
Above 960	43.5	Average	RBW = 1 MHz, VBW = 10 Hz

5.5.2. Method of Measurements

Refer to Ultratech Test Procedures ULTR-P001-2004 & ANSI C63.4 for method of measurements.

The spectrum shall be investigated from the lowest radio frequency signal generated or used in the device, without going below the lowest frequency for which a radiated emission limit is specified, up to the frequency shown in the following table:

Highest frequency generated or used in the device or on which the device operates or tunes (MHz)	Upper frequency of measurement range (MHz)
Below 1.705	30
1.705 – 108	1000
108 – 500	2000
500 -1000	5000
Above 1000	5 th harmonic of the highest frequency or 40 GHz, whichever is lower

5.5.3. Test Equipment List

Test Instruments	Manufacturer	Model No.	Serial No.	Frequency Range
EMI Receiver	Rohde & Schawrz	ESU 40	100037	20 Hz to 40 GHz
Pre Amplifier	AH System	PAM-0118	225	20 MHz to 18 GHz
Biconilog Antenna	EMCO	3142	1005	26 – 2 GHz
Horn Antenna	EMCO	3115	5955	1GHz – 18 GHz

5.5.4. Test Data

The emissions were scanned from 30 MHz to 6 GHz at 10 Meters distance and all emissions less than 20 dB below the limits were recorded.

FREQUENCY (MHz)	RF LEVEL (dBuV/m)	DETECTOR USED (PEAK/QP)	ANTENNA PLANE (H/V)	LIMIT (dBuV/m)	MARGIN (dB)	PASS/ FAIL
49.87	22.7	QP	V	29.5	-6.8	PASS
54.03	25.6	QP	V	29.5	-3.9	PASS
56.92	25.0	PEAK	V	29.5	-4.5	PASS
56.92	25.5	PEAK	H	29.5	-4.0	PASS
59.96	26.5	QP	V	29.5	-3.0	PASS
63.01	25.1	PEAK	V	29.5	-4.4	PASS
66.05	26.4	PEAK	V	29.5	-3.1	PASS
75.35	25.5	PEAK	V	29.5	-4.0	PASS
148.72	22.0	PEAK	V	33.0	-11.0	PASS
148.72	21.9	PEAK	H	33.0	-11.1	PASS
223.43	21.4	QP	V	35.5	-14.1	PASS
223.43	25.6	QP	H	35.5	-9.9	PASS
232.81	24.8	PEAK	V	35.5	-10.7	PASS
232.81	27.0	PEAK	H	35.5	-8.5	PASS
840.54	32.3	PEAK	V	35.5	-3.2	PASS
840.54	31.7	QP	H	35.5	-3.8	PASS
866.18	32.8	PEAK	V	35.5	-2.8	PASS
900.00	33.9	PEAK	H	35.5	-1.6	PASS
960.73	32.9	PEAK	V	43.5	-10.6	PASS

5.5.5. Plots

The following plots graphically represent the test results recorded in the above Test Data Table.

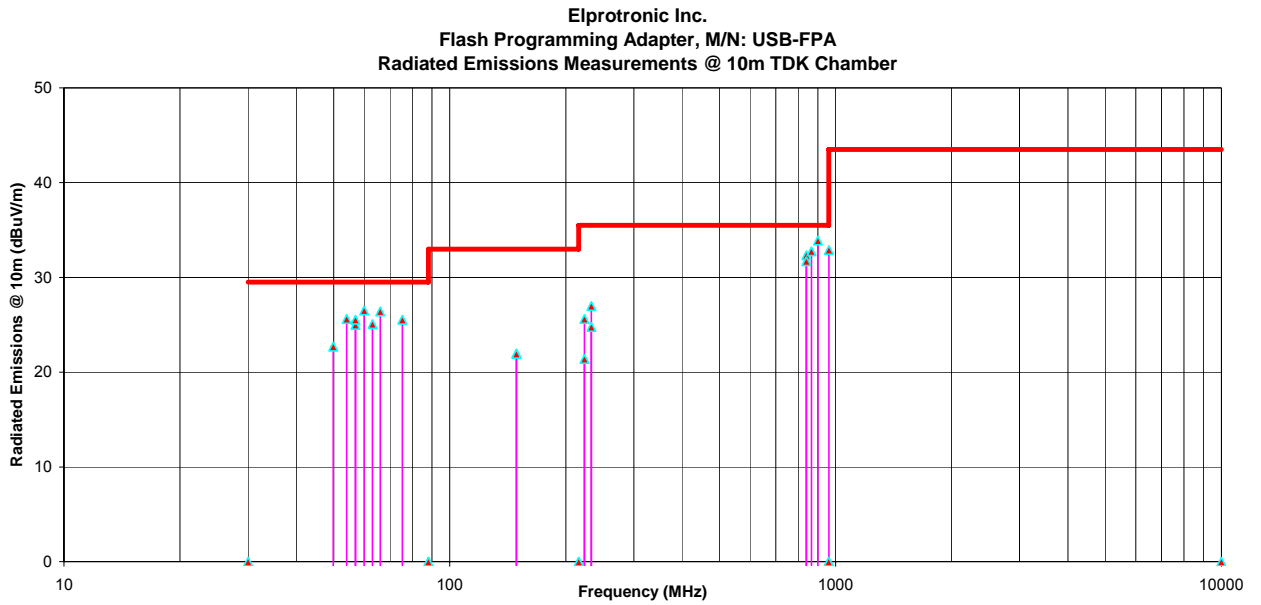

EXHIBIT 6. MEASUREMENT UNCERTAINTY

The measurement uncertainties stated were calculated in accordance with the requirements of NIST Technical Note 1297 and LAB 34

6.1. LINE CONDUCTED EMISSION MEASUREMENT UNCERTAINTY

CONTRIBUTION (Line Conducted)	PROBABILITY DISTRIBUTION	UNCERTAINTY (dB)	
		9-150 kHz	0.15-30 MHz
EMI Receiver specification	Rectangular	<u>+1.5</u>	<u>+1.5</u>
LISN coupling specification	Rectangular	<u>+1.5</u>	<u>+1.5</u>
Cable and Input Transient Limiter calibration	Normal (k=2)	<u>+0.3</u>	<u>+0.5</u>
Mismatch: Receiver VRC $\Gamma_1 = 0.03$ LISN VRC $\Gamma_R = 0.8(9 \text{ kHz}) 0.2 (30 \text{ MHz})$ Uncertainty limits $20\text{Log}(1 \pm \Gamma_1 \Gamma_R)$	U-Shaped	<u>+0.2</u>	<u>+0.3</u>
System repeatability	Std. deviation	<u>+0.2</u>	<u>+0.05</u>
Repeatability of EUT	--	--	--
Combined standard uncertainty	Normal	<u>+1.25</u>	<u>+1.30</u>
Expanded uncertainty U	Normal (k=2)	<u>+2.50</u>	<u>+2.60</u>

Sample Calculation for Measurement Accuracy in 150 kHz to 30 MHz Band:

$$u_c(y) = \sqrt{\sum_{i=1}^m u_i^2(y)} = \pm \sqrt{(1.5^2 + 1.5^2)/3 + (0.5/2)^2 + (0.05/2)^2 + 0.35^2} = \pm 1.30 \text{ dB}$$

$$U = 2u_c(y) = \pm 2.6 \text{ dB}$$

6.2. RADIATED EMISSION MEASUREMENT UNCERTAINTY

CONTRIBUTION (Radiated Emissions)	PROBABILITY DISTRIBUTION	Uncertainty (dB)	
		3m	10m
Antenna Factor Calibration	Normal (k=2)	+1.0	+1.0
Cable Loss Calibration	Normal (k=2)	+0.3	+0.5
EMI Receiver specification	Rectangular	+1.5	+1.5
Antenna Directivity	Rectangular	+0.5	+0.5
Antenna factor variation with height	Rectangular	+2.0	+0.5
Antenna phase center variation	Rectangular	0.0	+0.2
Antenna factor frequency interpolation	Rectangular	+0.25	+0.25
Measurement distance variation	Rectangular	+0.6	+0.4
Site imperfections	Rectangular	+2.0	+2.0
Mismatch: Receiver VRC $\Gamma_1 = 0.2$ Antenna VRC $\Gamma_R = 0.67(\text{Bi}) 0.3 (\text{Lp})$ Uncertainty limits $20\text{Log}(1+\Gamma_1\Gamma_R)$	U-Shaped	+1.1 -1.25	+0.5
System repeatability	Std. Deviation	+0.5	+0.5
Repeatability of EUT		-	-
Combined standard uncertainty	Normal	+2.19 / -2.21	+1.74 / -1.72
Expanded uncertainty U	Normal (k=2)	+4.38 / -4.42	+3.48 / -3.44

Calculation for maximum uncertainty when 10 M biconical antenna including a factor of k=2 is used:

$$U = 2u_c(y) = 2x(+2.19) = +4.38 \text{ dB} \quad \text{And} \quad U = 2u_c(y) = 2x(-2.21) = -4.42 \text{ dB}$$

EXHIBIT 7. LABELLING & FCC AUTHORIZATION REQUIREMENTS

7.1. SECTION 15.19 - LABELING REQUIREMENTS

(b) Products subject to authorization under a Declaration of Conformity shall be labelled as follows:

(1) The label shall be located in a conspicuous location on the device and shall contain the unique identification described in Section 2.1074 of this chapter and the following logo:

(i) If the product is authorized based on testing of the product or system:

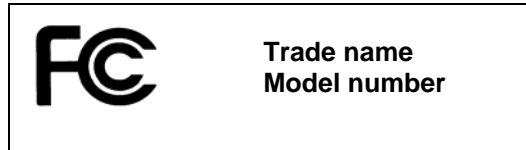

(ii) If the product is authorized based on assembly using separately authorized components, in accordance with Section 15.101(c)(2) or (c)(3), and the resulting product is not separately tested:

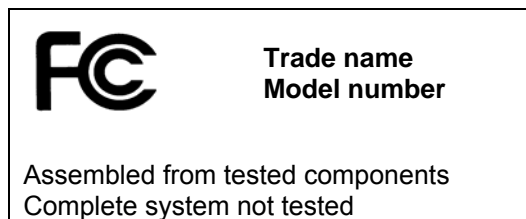

- (2) Label text and information should be in a size of type large enough to be readily legible, consistent with the dimensions of the equipment and the label. However, the type size for the text is not required to be larger than eight point.
- (3) When the device is so small or for such use that it is not practicable to place the statement specified under paragraph (b)(1) of this section on it, such as for a CPU board or a plug-in circuit board peripheral device, the text associated with the logo may be placed in a prominent location in the instruction manual or pamphlet supplied to the user. However, the unique identification (trade name and model number) and the logo must be displayed on the device.
- (4) The label shall not be a stick-on, paper label. The label on these products shall be permanently affixed to the product and shall be readily visible to the purchaser at the time of purchase, as described in Section 2.925(d) of this chapter. "Permanently affixed" means that the label is etched, engraved, stamped, silkscreened, indelibly printed, or otherwise permanently marked on a permanently attached
- (5) part of the equipment or on a nameplate of metal, plastic, or other material fastened to the equipment by welding, riveting, or a permanent adhesive. The label must be designed to last the expected lifetime of the equipment in the environment in which the equipment may be operated and must not be readily detachable.

7.2. SECTIONS 15.21 - INFORMATION TO USER

The users manual or instruction manual for an intentional or unintentional radiator shall caution the user as below:

Caution: Changes or modifications not expressly approved by the party responsible for compliance could void the user's authority to operate the equipment

In cases where the manual is provided only in a form other than paper, such as on a computer disk or over the Internet, the information required by this section may be included in the manual in that alternative form, provided the user can reasonably be expected to have the capability to access information in that form.

7.3. SECTIONS 15.105 - INFORMATION TO USER

The users manual or instruction manual for an intentional or unintentional radiator shall caution the user that changes or modifications not expressly approved by the party responsible for compliance could void the user's authority to operate the equipment.

- (a) For a Class B digital device or peripheral, the instructions furnished the user shall include the following or similar statement, placed in a prominent location in the text of the manual.

FCC INFORMATION TO USERS

This equipment has been tested and found to comply with the limits for a Class B digital devices, pursuant to Part 15 of the FCC Rules. These limits are designed to provide reasonable protection against harmful interference in a residential installation. This equipment generates, uses, and can radiate radio frequency energy and, if not installed and used in accordance with the instruction manual, may cause harmful interference to radio communications. However, there is no guarantee that interference will not occur in a particular installation. If this equipment does cause harmful interference to radio or television reception, which can be determined by turning the equipment off and on, the user is encouraged to try to correct the interference by one of more of the following measures:

- *Reorient or relocate the receiving antenna*
- *Increase the separation between the equipment and receiver*
- *Connect the equipment into an outlet on a circuit different from that to which the receiver is connected.*
- *Consult the dealer or an experienced radio/TV technician for help.*

7.4. SECTION 2.906 - DECLARATION OF CONFORMITY (DOC)

- (a) A Declaration of Conformity is a procedure where the responsible party, as defined in Section 2.909, makes measurements or takes other necessary steps to ensure that the equipment complies with the appropriate technical standards. Submittal of a sample unit or representative data to the Commission demonstrating compliance is not required unless specifically requested pursuant to Section 2.1076 of this part.
- (b) Declaration of Conformity attaches to all items subsequently marketed by the responsible party which are identical, as define in Section 2.908 of this part, to the sample tested and found acceptable by the responsible party.

7.5. SECTION 2.909 - RESPONSIBLE PARTY

The following parties are responsible for the compliance of radio frequency equipment with the applicable standards:

- (c) In the case of the equipment subject to authorization under the Declaration of Conformity procedure:
 - (1) The manufacturer or, if the equipment is assembled from individual component parts and the resulting system is subject to authorization under Declaration of Conformity, the assembler.
 - (2) If the equipment, by itself, is subject to Declaration of Conformity and the equipment is imported, the importer.

7.6. SECTION 2.945 - SAMPLING TEST OF EQUIPMENT COMPLIANCE

The Commission will, from time to time, request the responsible party to submit equipment subject to this chapter to determine the extent to which subsequent production of such equipment continues to comply with the data filed by the applicant (or on file with the responsible party for equipment subject to notification or a Declaration of Conformity). Shipping costs to the Commission's laboratory and return shall be borne by the responsible party.

7.7. SECTION 2.946 - PENALTY FOR FAILURE TO PROVIDE TEST SAMPLES AND DATA.

- (a) Any responsible party, as defined in Section 2.909 of this chapter, or nay party who markets equipment subject to the provisions of this chapter, shall provide test sample(s) or data upon request by the Commission. Failure to comply with such a request with the time frames shown below may be cause for forfeiture, pursuant to Section 1.80 of Part 1 of this chapter, or other administrative sanctions such as suspending action on any applications for equipment authorization submitted by such party while the matter is being resolved.
 - (1) When the equipment is subject to authorization under Declaration of Conformity, data shall be provided within 14 days of delivery of the request and test sample(s) shall be provided within 60 days of delivery of the request.
 - (2) For all other devices, test sample(s) or data shall be provided within 60 days of the request.
- (b) In the case of the equipment involving harmful interference or safety of life or property, the Commission may specify that test samples subject to the provisions of this section be submitted within less than 60 days, but not less than 14 days. Failure to comply within the specified time period will be subject to the sanctions specified in paragraph (a) of this section.

7.8. LIMITATION ON VERIFICATION: FCC PART 2, SUBPART J, SECTION 2.952

- (a) Verification signifies that the manufacturer or importer has determined that the equipment has been shown to be capable of compliance with the applicable technical standards if no unauthorized change is made in the equipment and if the equipment is properly maintained and operated. Compliance with these standards shall not be construed to be a finding by the manufacturer or importer with respect to matters not encompassed by the Commission's rules.
- (b) Verification of the equipment by the manufacturer or importer is effective until a termination date is otherwise established by the Commission.
- (c) No person shall, in any advertising matter, brochure, etc., use or make reference to a verification in a deceptive or misleading manner or convey the impression that such verification reflects more than a determination by the manufacturer or importer that the device or product has been shown to be capable of compliance with the applicable technical standards of the Commission's Rules.

7.9. RESPONSIBILITY OF MANUFACTURER OR IMPORTER: FCC PART 2, SUBPART J, SECTION 2.953

- (a) In verifying compliance, the manufacturer or importer (in the case of imported equipment) warrants that each unit of the equipment marketed under the verification procedure will conform to the unit tested and found acceptable by the manufacturer or importer and that data on file with the manufacturer or importer continues to be representative of the equipment being produced under such verification within the variation that can be expected due to quantity production and testing on a statistical basis.
- (b) The importer of equipment subject to verification may upon receiving a written statement from the manufacturer that the equipment complies with the appropriate technical standards rely on the manufacturer or independent testing agency to verify compliance. The test records required by Section 2.955 however should be in English language and made available to the Commission upon a reasonable request.
- (c) In the case of transfer of control of equipment, as in the case of sale or merger of the grantee, the new manufacturer or importer shall bear the responsibility of continued compliance of the equipment.
- (d) Equipment verified by the manufacturer or importer shall be re-verified if the modification or change adversely affects the emanation characteristics of the modified equipment. The manufacturer or importer continues to bear the responsibility for continued compliance of subsequently produced equipment.

7.10. IDENTIFICATION: FCC PART 2, SUBPART J, SECTION 2.954

The identification of equipment subject to verification shall be consistent with current manufacturer or marketing practices: *Provided*, The manufacturer or importer maintains adequate identification records for each unit verified to facilitate positive identification of each equipment marketed.

7.11. RETENTION OF RECORDS: FCC PART 2, SUBPART J, SECTION 2.955

- (a) For each equipment subject to verification, the manufacturer (or importer) shall maintain the records listed below:
 - (1) A record of the original design drawings and specifications and all changes that have been made that may affect compliance with the requirements of Section 2.953.
 - (2) A record of the procedures used for production inspection and testing (if tests were performed) to insure the conformance required by Section 2.953. (Statistical production line emission testing is not required).

- (b) The records listed in paragraphs (a) of this section shall be retained for two years after the manufacture of said equipment item has been permanently discontinued, or until the conclusion of an investigation or a proceeding if the manufacturer or importer is officially notified that an investigation or any other administrative proceeding involving his equipment has been instituted.

7.12. FCC INSPECTION & SUBMISSION OF EQUIPMENT FOR TESTING: FCC PART 2, SUBPART J, SEC. 2.956

- (a) Each manufacturer or importer of equipment subject to verification shall upon receipt of reasonable request submit to the Commission the records required by Section 2.955.
- (b) The Commission may require the manufacturer or importer of equipment subject to verification to submit one or more of sample units for measurements at the Commission's Laboratory.
- (c) In the event the manufacturer believes that shipment of the sample to the Commission's Laboratory is impractical because of the size or weight of the equipment, or the power requirement or for any other reason, the applicant may submit a written explanation why such shipment is impractical and should not be required.

7.13. SAMPLING TESTS OF EQUIPMENT COMPLIANCE: FCC PART 2, SUBPART J, SECTION 2.957

The Commission will from time to time, request the manufacturer or importer to submit to the FCC Laboratory in Columbia, Maryland, various equipment(s) for which verification has been made, to determine the extent to which subsequently produced units continue to comply with the applicable standards.

EXHIBIT 8. PHOTOGRAPHS OF EQUIPMENT UNDER TEST



